

Unidad 14 Principios de representación

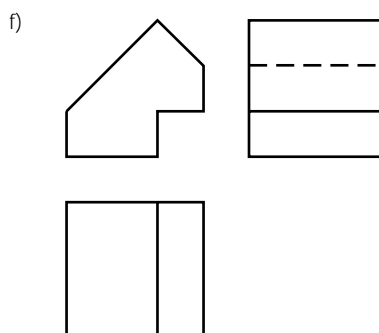
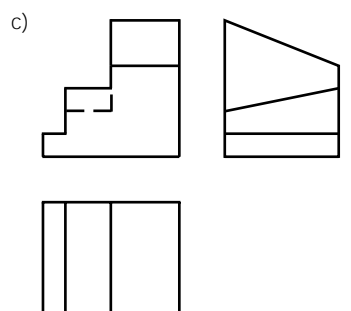
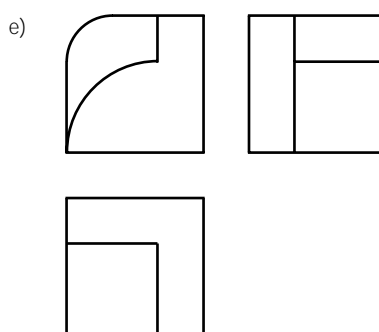
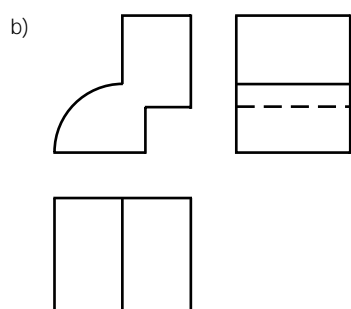
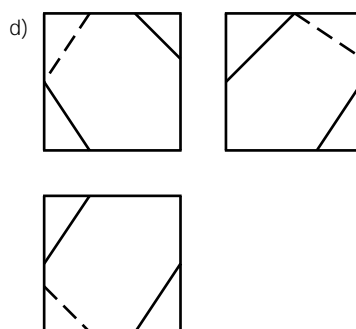
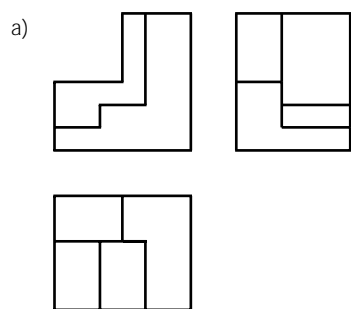

Centro		Alumno/a:			n.º
Escala	Tema: Vistas 1	Curso	Nota	Actividad n.º 42	Fecha

Unidad 14 Principios de representación

a Dadas dos vistas de las siguientes figuras, obtener la tercera vista.

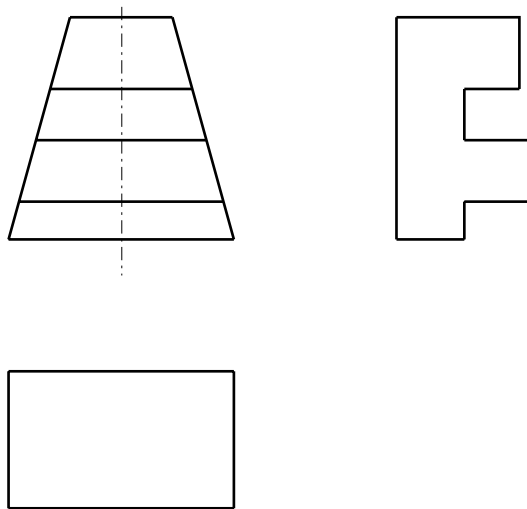

b Dadas dos vistas de las siguientes figuras, obtener la tercera vista.

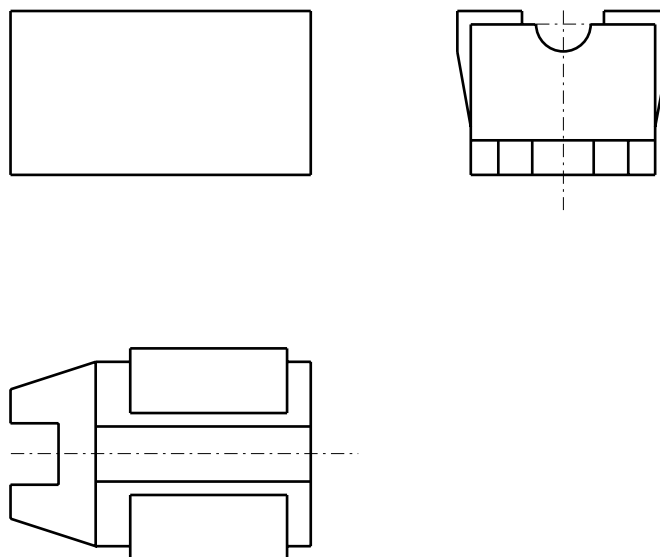

Centro		Alumno/a:			n.º
<i>Escala</i>	<i>Tema:</i> Vistas 3	<i>Curso</i>	<i>Nota</i>	<i>Actividad n.º</i> 42	<i>Fecha</i>

Unidad 14 Principios de representación

a Dadas dos vistas de las siguientes figuras, obtener la tercera vista.

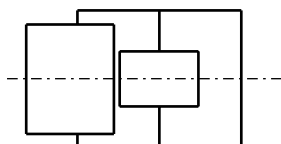
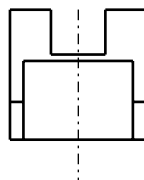
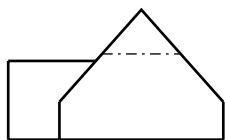

b Dadas dos vistas de las siguientes figuras, obtener la tercera vista.

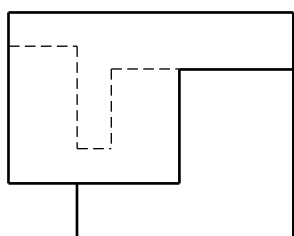
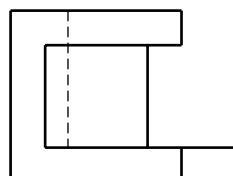
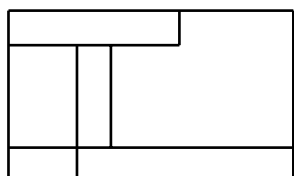

Centro		Alumno/a:			n.º
<i>Escala</i>	<i>Tema:</i> Vistas 3	<i>Curso</i>	<i>Nota</i>	<i>Actividad n.º</i> 42	<i>Fecha</i>